

I - Per stringere, usare la chiave come indicato nel disegno. (Non si assumono responsabilità per danni causati dall'impiego di chiavi diverse da quella in dotazione al prodotto).
F - Pour serrer, utiliser la clé comme indique ci dessous.

GB - To tighten please use the wrench as per the drawing.
D - Zum Anziehen benutzen Sie bitte den Inbusschlüssel, nur wie auf dem Bild dargestellt.
E - Para el correcto ajuste, utilizar la llave fija tal y como se indica en la imagen

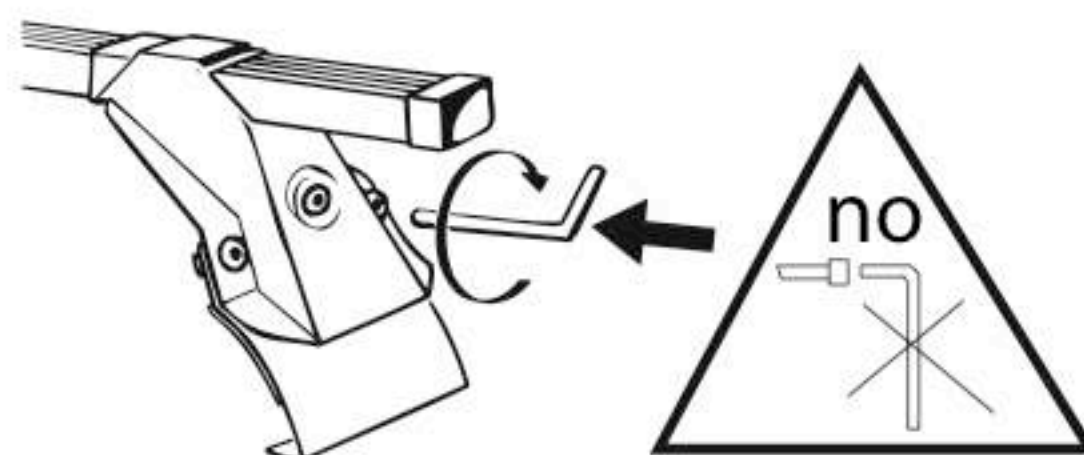

LA PREALPINA srl

INDUSTRIA ACCESSORI AUTO
10040 VOLVERA (Torino) ITALY
Strada Orbassano, 47
tel. 011 985 06 83, Fax 011 985 72 76
<http://www.laprealpina.net>; e-mail: lp@laprealpina.it

05/10/2015
Rev. 0