

L1452

VOLKSWAGEN

TOURAN mod. 2015 NO RAILS

max
Kg. 60

L2

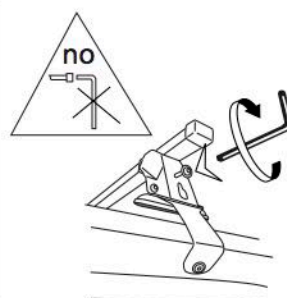
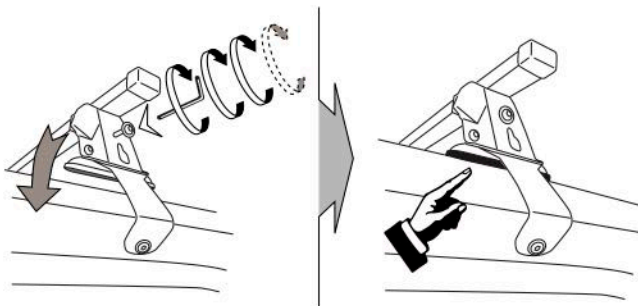
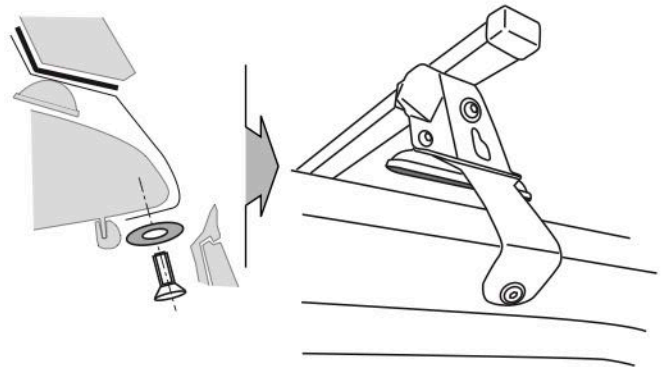
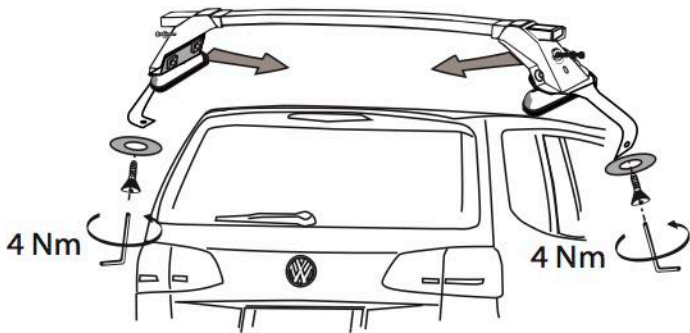
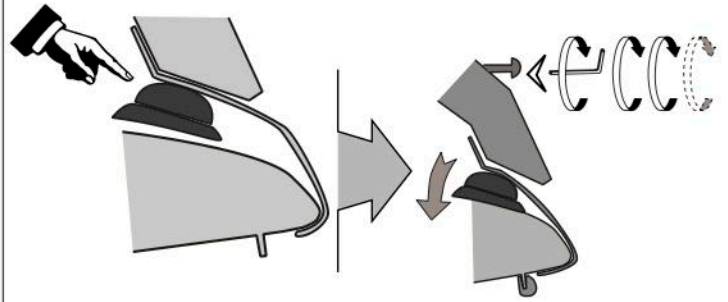
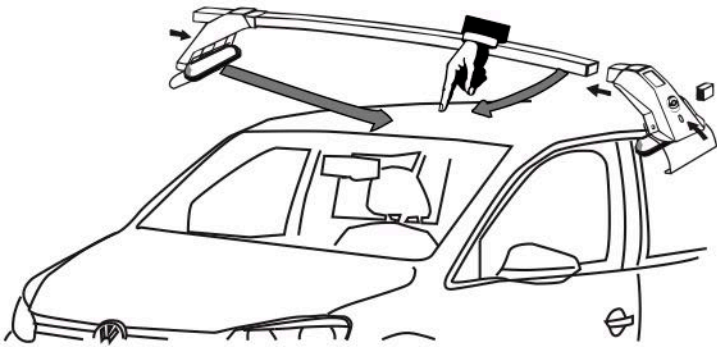
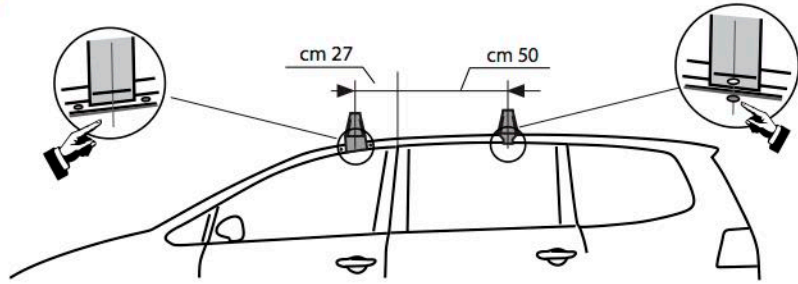

I - Per stringere, usare la chiave come indicato nel disegno. (Non si assumono responsabilità per danni causati dall'impiego di chiavi diverse da quella in dotazione al prodotto).

F - Pour serrer, utiliser la clé comme indiqué ci dessous.

GB - To tighten please use the wrench as per the drawing.

D - Zum Anziehen benutzen Sie bitte den Inbusschlüssel, nur wie auf dem Bild dargestellt.

E - Para el correcto ajuste, utilizar la llave fija tal y como se indica en la imagen

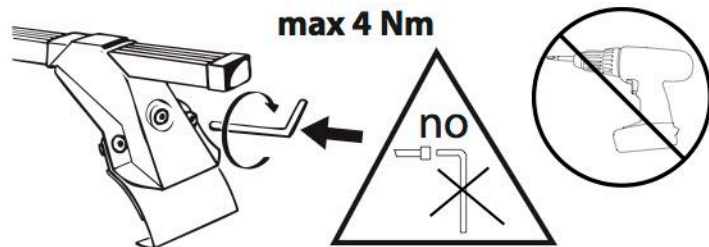

LA PREALPINA srl

INDUSTRIA ACCESSORI AUTO
10040 VOLVERA (Torino) ITALY
Strada Orbassano, 47

tel. 011 985 06 83, Fax 011 985 72 76

<http://www.laprealpina.net>; e-mail: lp@laprealpina.it

24/10/2016

Rev. 0